

KOMATSU

PC240LC-11 PC240NLC-11



Hydraulic excavator

Engine power

141 kW / 189 HP @ 2000 rpm

Operating weight

PC240LC-11: 25300 - 27530 kg
PC240NLC-11: 24700 - 26630 kg

Bucket capacity

max. 1.89 m³

PC240LC/NLC-11



Engine power
141 kW / 189 HP @ 2000 rpm

Operating weight
PC240LC-11: 25300 - 27530 kg
PC240NLC-11: 24700 - 26630 kg

Bucket capacity
max. 1.89 m³

Exceptional workability and environmental performance

Powerful and environmentally friendly

- EU Stage V engine
- Adjustable idle shutdown
- Komatsu fuel-saving technology

First-class comfort

- Fully air-suspended operator station
- Low-noise design
- Widescreen monitor

Maximised efficiency

- Increased productivity
- Built-in versatility and superior productivity
- Enhanced engine management
- Improved hydraulic efficiency
- Komatsu Integrated Attachment Control (KIAC)

Safety first

- Komatsu SpaceCab™
- KomVision surround view system
- Neutral position detection system

Quality you can rely on

- Komatsu-quality components
- Extensive dealer support network

Komtrax

- Komatsu Wireless Monitoring System
- 4G mobile communications
- Integrated communication antenna
- Increased operational data and reports



A maintenance program for Komatsu customers



Higher productivity

The PC240LC/NLC-11 is quick and precise. It features a powerful Komatsu EU Stage V engine, Komatsu's Closed Center Load Sensing (CLSS) hydraulic system and first-class Komatsu comfort to provide a fast response and unrivalled productivity for its class.

Komatsu fuel-saving technology

Fuel consumption on the PC240LC/NLC-11 is lower by up to 6%. Engine management is enhanced. The variable speed matching of the engine and hydraulic pump and a viscous fan clutch guarantee efficiency and precision during single and combined movements.

Adjustable idle shutdown

The Komatsu auto idle shutdown automatically turns off the engine after it idles for a set period of time. This feature can easily be programmed from 5 to 60 minutes, to reduce unnecessary fuel consumption and exhaust emissions, and to lower operating costs. An Eco-gauge and the Eco guidance tips on the cab monitor further encourage efficient operations.

Powerful and environmentally friendly

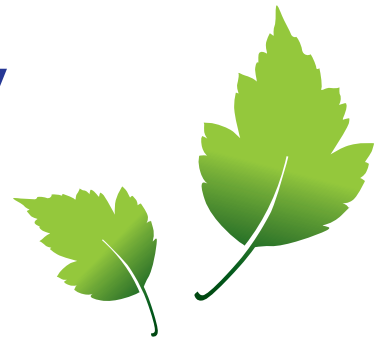

Komatsu EU Stage V

The Komatsu EU Stage V engine is productive, dependable and efficient. With ultra-low emissions, it provides a lower environmental impact and a superior performance to help reduce operating costs and lets the operator work in complete peace of mind.

Heavy-duty aftertreatment

The aftertreatment system combines a Komatsu Diesel Particulate Filter (KDPF) and Selective Catalytic Reduction (SCR). The SCR injects the correct amount of AdBlue® into the system at the proper rate to break down NOx into water (H₂O) and non-toxic nitrogen gas (N₂). NOx emissions are reduced by 80% vs. EU Stage IIIB engines.

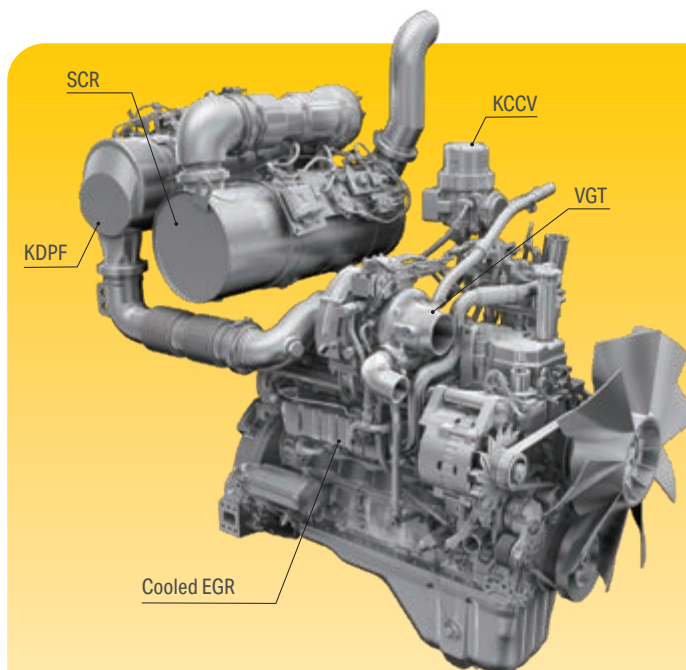
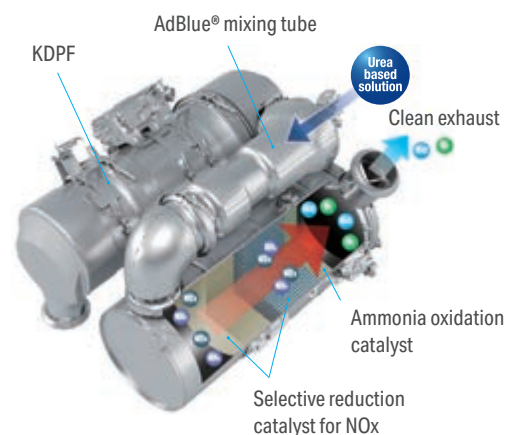

High-Pressure Common Rail (HPCR)

To achieve complete fuel burn and lower exhaust emissions, the heavy-duty High-Pressure Common Rail fuel injection system is computer controlled to deliver a precise quantity of pressurised fuel into the redesigned engine combustion chamber by multiple injections.

Exhaust Gas Recirculation (EGR)

Cooled EGR is a technology well-proven in current Komatsu engines. The increased capacity of the EGR cooler now ensures very low NOx emissions and a better engine performance.

Komatsu Closed Crankcase Ventilation (KCCV)

Crankcase emissions (blow-by gas) are passed through a CCV filter. The oil mist trapped in the filter is returned back to the crankcase while the filtered gas is returned to the air intake.

Variable Geometry Turbo (VGT)

The VGT provides optimal airflow to the engine combustion chamber under all speed and load conditions. Exhaust gas is cleaner, fuel economy is improved while machine power and performance are maintained.

PC240LC/NLC-11

A wide choice of options

Two optional attachment lines are available and 15 attachment memory settings are simply customised. Combined with a standard-fit hydraulic quick coupler power circuit, it's easier than ever to switch working styles. With a choice of arms and undercarriages, you can configure the PC240LC/NLC-11 to match specific demands for transport, working envelope or duty.

6 working modes

The PC240LC/NLC-11 delivers the power required with the lowest fuel usage. 6 working modes are available: Power, Lifting, Breaker, Economy, Attachment Power and Attachment Economy. The operator can ideally balance the Economy mode between power and economy to match the work at hand. The oil flow delivered to hydraulic attachments is also adjustable directly on the class-leading widescreen monitor panel.



Two-piece boom



Two optional hydraulic lines to mount a variety of attachments



Komatsu Integrated Attachment Control (KIAC) for up to 15 tool presets for oil flow and pressure



Versatility at your fingertips: select the perfect setting for each job





Maximised efficiency

Built-in versatility

Powerful and precise, the Komatsu PC240LC/NLC-11 is equipped to efficiently carry out any task your business requires. On all jobsites, big or small, for digging, trenching, landscaping or site preparation, the Komatsu hydraulic system always provides maximum productivity and control.

First-class comfort

Increased comfort

In the wide Komatsu SpaceCab™, a standard air-suspended high-back seat, heated for improved comfort and with fully adjustable armrests, is the centre of a comfortable and low-fatigue working environment. High visibility and ergonomic controls further assist to maximise the operator's productivity.

Perfect operator convenience

In addition to the standard radio, the PC240LC/NLC-11 has an auxiliary input for connecting external devices and play music through the cab speakers. Two 12-volt power ports are also incorporated in the cab. Proportional controls are fitted as standard for safe and precise operation of attachments.

Low-noise design

Komatsu crawler excavators have very low external noise levels and are especially well-suited for work in confined spaces or urban areas. The optimal usage of sound insulation and of sound absorbing materials helps to make noise levels inside the cab comparable to those of an executive car.



Convenient, ergonomic and precise control: joysticks with proportional control button for attachments



Plenty of storage room, a hot and cool box, a magazine box and a cup holder



Armrest with simple height adjustment



Safety first

Optimal jobsite safety

Safety features on the Komatsu PC240LC/NLC-11 comply with the latest industry standards and work in synergy to minimise risks to people in and around the machine. A neutral detection system for travel and work equipment levers increase jobsite safety, along with a seat belt caution indicator and an audible travel alarm. Highly durable anti-slip plates – with additional high friction covering – maintain long term traction performance.



Safe maintenance

Thermal guards around high temperature areas of the engine, protected fan belt and pulleys, a pump/engine partition that prevents hydraulic oil from spraying onto the engine, a wide catwalk and exceptionally sturdy handrails: in Komatsu tradition, the highest safety level is provided for a fast and smooth maintenance.



Komatsu SpaceCab™

The ROPS cab has a tubular steel frame and provides high shock absorbercy, impact resistance and durability. The seat belt is well designed to keep the operator in the safety zone of the cab in the event of a rollover. Optionally the cab can be fitted with a Falling Object Protective System (FOPS) with openable front guard.



KomVision

KomVision machine visibility gives the operator a constant clear view of the safety zone around the machine. This allows the operator to focus on the work at hand even in low light conditions.



An evolutionary interface

Helpful information is now easier than ever to find and understand with the upgraded monitor interface. An optimal main screen for the ongoing work can be selected simply by pressing the F3 key.

Lower operating costs

Komatsu ICT contributes to the reduction of operating costs by assisting to comfortably and efficiently manage operations. It raises the level of customer satisfaction and the competitive edge of our products.

Widescreen monitor

Conveniently customisable and with a choice of 26 languages, the widescreen monitor with simple switches and multifunction keys gives fingertip access to a large range of functions and operating info. The rear camera view and an AdBlue® level gauge are now incorporated into the default main screen.



Quick view on the operation logs



With KomVision, various camera view options are available whilst maintaining constant "birdview" from above the machine



Operator identification function

Information & communication technology



Knowledge

You get quick answers to basic and critical questions about your machines – what they're doing, when they did it, where they're located, how they can be used more efficiently and when they need to be serviced. Performance data is relayed by wireless communication technology (satellite, GPRS or 4G depending on model) from the machine to a computer and to the local Komatsu distributor – who's readily available for expert analysis and feedback.

Convenience

Komtrax enables convenient fleet management on the web, wherever you are. Data is analysed and packaged specifically for effortless and intuitive viewing in maps, lists, graphs and charts. You can foresee eventual maintenance issues and required spare parts, and troubleshoot a problem before Komatsu technicians arrive on site.



The way to higher productivity

Komtrax uses the latest wireless monitoring technology. Compatible on PC, smartphone or tablet, it delivers insightful and cost saving information about your fleet and equipment, and offers a wealth of information to facilitate peak machine performance. By creating a tightly integrated web of support it allows proactive and preventive maintenance and helps to efficiently run a business.

Power

The detailed information that Komtrax puts at your fingertips 24 hours a day, 7 days a week gives the power to make better daily and long-term strategic decisions – at no extra cost. Problems can be anticipated, maintenance schedules customised, downtime minimised and machines kept where they belong: working on the jobsite.



Easy maintenance



Central service points

Komatsu designed the PC240LC/NLC-11 with centralised and conveniently located service points to make necessary inspections and maintenance quick and easy.

Komatsu Care

Komatsu Care is a maintenance program that comes as standard with your new Komatsu machine. It covers factory-scheduled maintenance, performed with Komatsu Genuine parts by Komatsu-trained technicians. Depending on your machine's engine, it also offers extended coverage of the Komatsu Diesel Particulate Filter (KDPF) and of the Selective Catalytic Reduction (SCR). Please contact your local Komatsu distributor for terms and conditions.

Long-life oil filters

The Komatsu Genuine hydraulic oil filter uses high-performance filtering material for long replacement intervals, which significantly reduces maintenance costs.



AdBlue® tank

For simple access, the AdBlue® tank is installed on the front stairway.

Flexible warranty

When you purchase Komatsu equipment, you gain access to a broad range of programmes and services that have been designed to help you get the most from your investment. For example, Komatsu's Flexible Warranty Programme provides a range of extended warranty options on the machine and its components. These can be chosen to meet your individual needs and activities. This programme is designed to help reduce total operating costs.

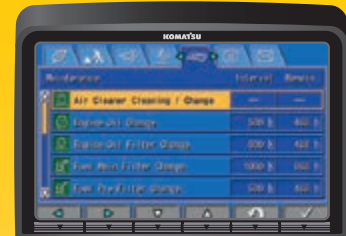

Basic maintenance screen

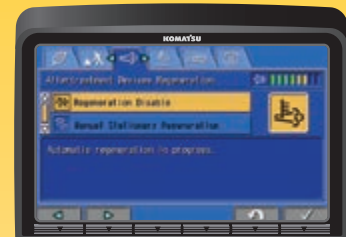

Aftertreatment device regeneration screen for the KDPF

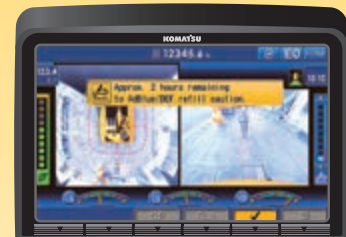

AdBlue® level and refill guidance



Quality you can rely on

Komatsu-quality

With the latest computer techniques and a thorough test programme, Komatsu produces equipment to meet your highest standards. All major components of the PC240LC/NLC-11 are designed and directly manufactured by Komatsu, and essential machine functions are perfectly matched for a highly reliable and productive excavator.

Rugged design

Maximum toughness and durability are the cornerstones of Komatsu's philosophy – along with safety and top class customer service. Single piece plates and castings are used in key areas of the machine's structure for good load distribution. Highly durable rubbing strips on the underside of the arm protect the structure against impact damage.

Extensive support network

The extensive Komatsu distribution and dealer network is standing by to help keep your fleet in optimum condition. Customised servicing packages are available, with express availability of spare parts, to make sure that your Komatsu equipment continues to perform at its peak.



Durable and reliable undercarriage design for maximum protection



Cast boom foot and single piece boom plates

Specifications

Engine

| | |
|-----------------------------|---|
| Model | Komatsu SAA6D107E-3 |
| Type | Common rail direct injection, water-cooled, emissionised, turbocharged, after-cooled diesel |
| Engine power | |
| at rated engine speed | 2000 rpm |
| ISO 14396 | 141 kW / 189 HP |
| ISO 9249 (net engine power) | 132 kW / 177 HP |
| No. of cylinders | 6 |
| Bore × stroke | 107 × 124 mm |
| Displacement | 6.69 l |
| Air filter type | Double element type with monitor panel dust indicator and auto dust evacuator |
| Cooling | Suction type cooling fan with radiator fly screen |
| Fuel | Diesel fuel, conforming to EN590 Class 2/Grade D. Paraffinic fuel capability (HVO, GTL, BTL), conforming to EN 15940:2016 |

Hydraulic system

| | |
|-----------------------|---|
| Type | HydrauMind. Closed-centre system with load sensing and pressure compensation valves |
| Additional circuits | 2 additional circuits with proportional control can be installed |
| Main pump | 2 variable displacement piston pumps supplying boom, arm, bucket, swing and travel circuits |
| Maximum pump flow | 2 × 237.5 l/min |
| Relief valve settings | |
| Implement | 380 kg/cm ² |
| Travel | 380 kg/cm ² |
| Swing | 295 kg/cm ² |
| Pilot circuit | 33 kg/cm ² |

Service refill capacities

| | |
|-------------------------|--------|
| Fuel tank | 400 l |
| Radiator | 36.0 l |
| Engine oil | 23.1 l |
| Swing drive | 7.2 l |
| Hydraulic tank | 132 l |
| Final drive (each side) | 5.0 l |
| AdBlue® tank | 23.1 l |

Swing system

| | |
|--------------|---|
| Type | Axial piston motor driving through planetary double reduction gearbox |
| Swing lock | Electrically actuated wet multidisc brake integrated into swing motor |
| Swing speed | 0 - 11.7 rpm |
| Swing torque | 75 kNm |

Drives and brakes

| | |
|----------------------|--|
| Steering control | 2 levers with pedals giving full independent control of each track |
| Drive method | Hydrostatic |
| Travel operation | Automatic 3-speed selection |
| Gradeability | 70%, 35° |
| Max. travel speeds | |
| Lo / Mi / Hi | 3.0 / 4.1 / 5.5 km/h |
| Maximum drawbar pull | 20570 kg |
| Brake system | Hydraulically operated discs in each travel motor |

Undercarriage

| | |
|-----------------------------|--|
| Construction | X-frame centre section with box section track frames |
| Track assembly | |
| Type | Fully sealed |
| Shoes (each side) | 51 (PC240LC), 49 (PC240NLC) |
| Tension | Combined spring and hydraulic unit |
| Rollers | |
| Track rollers (each side) | 10 (PC240LC), 9 (PC240NLC) |
| Carrier rollers (each side) | 2 |

Environment

| | |
|---|---|
| Engine emissions | Fully complies with EU Stage V exhaust emission regulations |
| Noise levels | |
| LwA external | 103 dB(A) (2000/14/EC Stage II) |
| LpA operator ear | 70 dB(A) (ISO 6396 dynamic test) |
| Vibration levels (EN 12096:1997) | |
| Hand/arm | ≤ 2.5 m/s ² (uncertainty K = 0.53 m/s ²) |
| Body | ≤ 0.5 m/s ² (uncertainty K = 0.28 m/s ²) |
| Contains fluorinated greenhouse gas HFC-134a (GWP 1430). Quantity of gas 0.9 kg, CO ₂ equivalent 1.29 t | |

Operating weight (appr.) – Mono boom

| Triple grouser shoes | PC240LC-11 | | PC240NLC-11 | |
|----------------------|------------------|-------------------------|------------------|-------------------------|
| | Operating weight | Ground pressure | Operating weight | Ground pressure |
| 600 mm | 25300 kg | 0.51 kg/cm ² | 24700 kg | 0.52 kg/cm ² |
| 700 mm | 25600 kg | 0.44 kg/cm ² | 25000 kg | 0.45 kg/cm ² |
| 800 mm | 25900 kg | 0.39 kg/cm ² | 25300 kg | 0.40 kg/cm ² |
| 900 mm | 26200 kg | 0.35 kg/cm ² | - | - |

Operating weight, including specified work equipment, 3.0 m arm, 735 kg bucket, operator, lubricant, coolant, full fuel tank and the standard equipment.

Operating weight (appr.) – Two-piece boom

| Triple grouser shoes | PC240LC-11 | | PC240NLC-11 | |
|----------------------|------------------|-------------------------|------------------|-------------------------|
| | Operating weight | Ground pressure | Operating weight | Ground pressure |
| 600 mm | 26630 kg | 0.54 kg/cm ² | 26030 kg | 0.55 kg/cm ² |
| 700 mm | 26930 kg | 0.46 kg/cm ² | 26330 kg | 0.47 kg/cm ² |
| 800 mm | 27230 kg | 0.41 kg/cm ² | 26630 kg | 0.42 kg/cm ² |
| 900 mm | 27530 kg | 0.37 kg/cm ² | - | - |

Operating weight, including specified work equipment, 3.0 m arm, 735 kg bucket, operator, lubricant, coolant, full fuel tank and the standard equipment.

Dimensions and performance figures

| Machine dimensions | PC240LC-11 | PC240NLC-11 |
|--|-----------------------|------------------|
| A Overall width of upper structure | 2705 mm | 2705 mm |
| B Overall height of cab | 3055 mm | 3055 mm |
| C Overall length of basic machine | 5305 mm | 5210 mm |
| D Tail length | 2985 mm | 2985 mm |
| Tail swing radius | 3020 mm | 3020 mm |
| E Clearance under counterweight | 1100 mm | 1100 mm |
| F Machine tail height | 2265 mm | 2265 mm |
| F' Machine tail height (top of engine cover) | 2780 mm | 2780 mm |
| G Ground clearance | 440 mm | 440 mm |
| H Tumbler centre distance | 3845 mm | 3655 mm |
| I Track length | 4640 mm | 4450 mm |
| J Track gauge | 2580 mm | 2380 mm |
| K Track shoe width | 600, 700, 800, 900 mm | 600, 700, 800 mm |
| L Overall track width with 600 mm shoes | 3180 mm | 2980 mm |
| Overall track width with 700 mm shoes | 3280 mm | 3080 mm |
| Overall track width with 800 mm shoes | 3380 mm | 3180 mm |
| Overall track width with 900 mm shoes | 3480 mm | - |

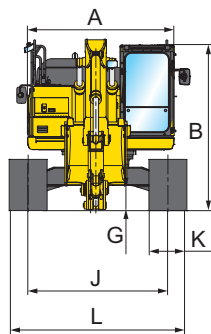

Mono boom

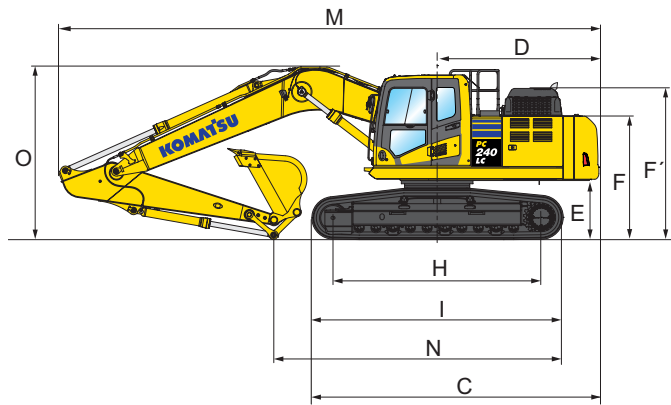

Two-piece boom

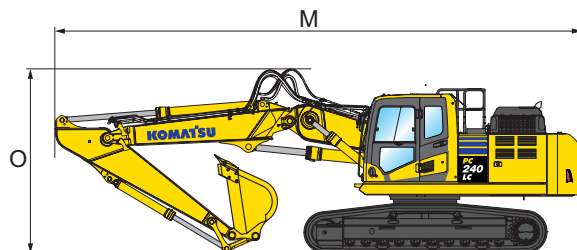

| Transport dimensions | Mono boom | | | | Two-piece boom | | |
|--|-----------|----------|---------|----------|----------------|----------|----------|
| Arm length | 2.0 m | 2.5 m | 3.0 m | 3.5 m | 2.5 m | 3.0 m | 3.5 m |
| M Transport length | 9945 mm | 10040 mm | 9965 mm | 10010 mm | 10170 mm | 10120 mm | 10100 mm |
| N Length on ground (transport) PC240LC | 6600 mm | 6115 mm | 5390 mm | 4950 mm | 6795 mm | 6170 mm | 5895 mm |
| Length on ground (transport) PC240NLC | 6460 mm | 6020 mm | 5260 mm | 4860 mm | 6700 mm | 6700 mm | 5800 mm |
| O Overall height (to top of boom) (to top of hose) | 3220 mm | 3295 mm | 3185 mm | 3270 mm | 3445 mm | 3540 mm | 3680 mm |

PC240LC-11 / Max. bucket capacity and weight

| Arm length | Mono boom | | | |
|--|-----------------------------|-----------------------------|-----------------------------|-----------------------------|
| | 2.0 m | 2.5 m | 3.0 m | 3.5 m |
| Material weight up to 1.2 t/m ³ | 1.89 m ³ 1300 kg | 1.89 m ³ 1300 kg | 1.89 m ³ 1300 kg | 1.82 m ³ 1250 kg |
| Material weight up to 1.5 t/m ³ | 1.89 m ³ 1300 kg | 1.82 m ³ 1250 kg | 1.64 m ³ 1175 kg | 1.54 m ³ 1125 kg |
| Material weight up to 1.8 t/m ³ | 1.67 m ³ 1175 kg | 1.58 m ³ 1125 kg | 1.40 m ³ 1075 kg | 1.33 m ³ 1025 kg |

PC240NLC-11 / Max. bucket capacity and weight

| Arm length | Mono boom | | | |
|--|-----------------------------|-----------------------------|-----------------------------|-----------------------------|
| | 2.0 m | 2.5 m | 3.0 m | 3.5 m |
| Material weight up to 1.2 t/m ³ | 1.89 m ³ 1300 kg | 1.89 m ³ 1225 kg | 1.70 m ³ 1125 kg | 1.58 m ³ 1100 kg |
| Material weight up to 1.5 t/m ³ | 1.70 m ³ 1175 kg | 1.59 m ³ 1125 kg | 1.44 m ³ 1050 kg | 1.34 m ³ 1000 kg |
| Material weight up to 1.8 t/m ³ | 1.47 m ³ 1075 kg | 1.38 m ³ 1025 kg | 1.20 m ³ 975 kg | 1.16 m ³ 950 kg |

PC240LC-11 / Max. bucket capacity and weight

| Arm length | Two-piece boom | | |
|--|-----------------------------|-----------------------------|-----------------------------|
| | 2.5 m | 3.0 m | 3.5 m |
| Material weight up to 1.2 t/m ³ | 2.16 m ³ 1405 kg | 1.95 m ³ 1310 kg | 1.83 m ³ 1255 kg |
| Material weight up to 1.5 t/m ³ | 1.83 m ³ 1255 kg | 1.65 m ³ 1175 kg | 1.55 m ³ 1130 kg |
| Material weight up to 1.8 t/m ³ | 1.58 m ³ 1150 kg | 1.43 m ³ 1080 kg | 1.34 m ³ 1040 kg |

PC240NLC-11 / Max. bucket capacity and weight

| Arm length | Two-piece boom | | |
|--|-----------------------------|-----------------------------|-----------------------------|
| | 2.5 m | 3.0 m | 3.5 m |
| Material weight up to 1.2 t/m ³ | 1.95 m ³ 1310 kg | 1.74 m ³ 1215 kg | 1.65 m ³ 1175 kg |
| Material weight up to 1.5 t/m ³ | 1.65 m ³ 1175 kg | 1.47 m ³ 1095 kg | 1.39 m ³ 1060 kg |
| Material weight up to 1.8 t/m ³ | 1.43 m ³ 1080 kg | 1.27 m ³ 1010 kg | 1.21 m ³ 980 kg |

Max. capacity and weight have been calculated according to ISO 10567:2007.

Please consult with your distributor for the correct selection of buckets and attachments to suit the application.

Bucket and arm force

| Arm length | 2.0 m | 2.5 m | 3.0 m | 3.5 m |
|----------------------------------|----------|----------|----------|----------|
| Bucket digging force | 18800 kg | 18800 kg | 16200 kg | 16200 kg |
| Bucket digging force at PowerMax | 20100 kg | 20100 kg | 17500 kg | 17500 kg |
| Arm crowd force | 15300 kg | 14100 kg | 12300 kg | 10500 kg |
| Arm crowd force at PowerMax | 16400 kg | 15100 kg | 13200 kg | 11200 kg |

Working range

Mono boom

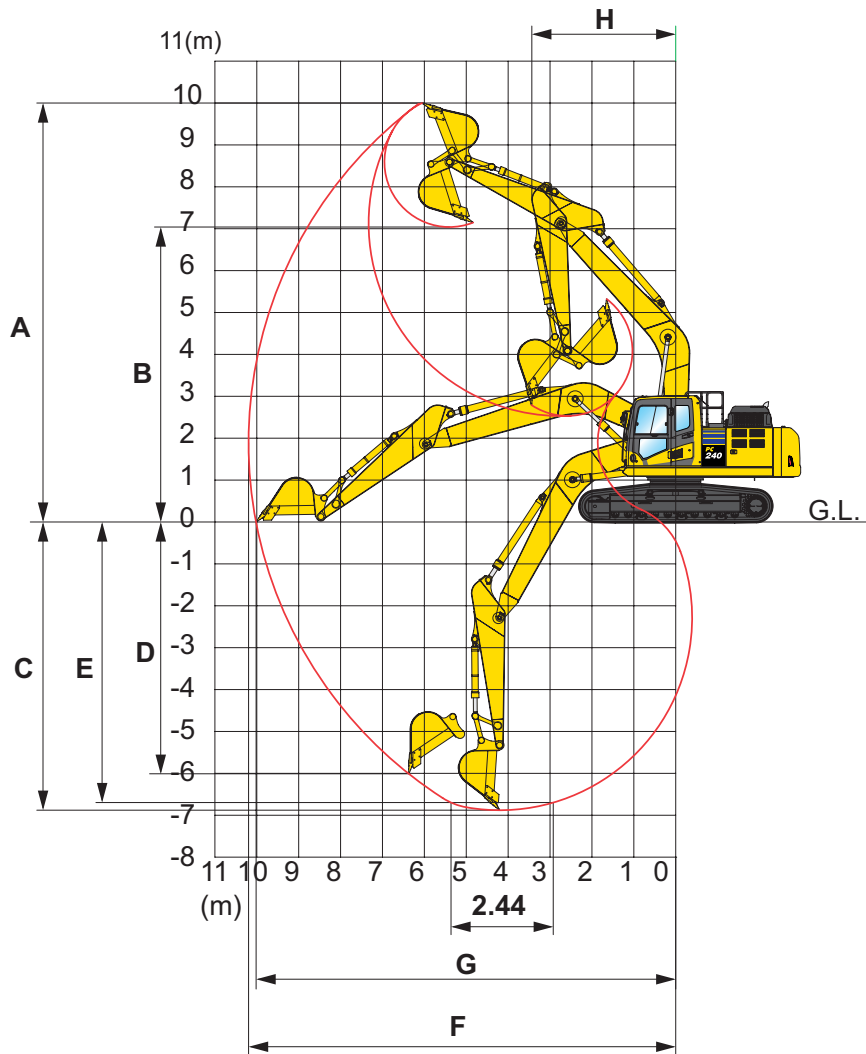

Working range

| Arm length | 2.0 m | 2.5 m | 3.0 m | 3.5 m |
|--|---------|---------|----------|----------|
| A Max. digging height | 9665 mm | 9790 mm | 10000 mm | 10300 mm |
| B Max. dumping height | 6715 mm | 6860 mm | 7035 mm | 7360 mm |
| C Max. digging depth | 5825 mm | 6320 mm | 6920 mm | 7320 mm |
| D Max. vertical wall digging depth | 4750 mm | 5130 mm | 6010 mm | 6230 mm |
| E Max. digging depth of cut for 2.44 m level | 5585 mm | 6100 mm | 6700 mm | 7150 mm |
| F Max. digging reach | 9270 mm | 9670 mm | 10180 mm | 10580 mm |
| G Max. digging reach at ground level | 9070 mm | 9480 mm | 10020 mm | 10420 mm |
| H Min. swing radius | 3300 mm | 3320 mm | 3450 mm | 3340 mm |

Two-piece boom

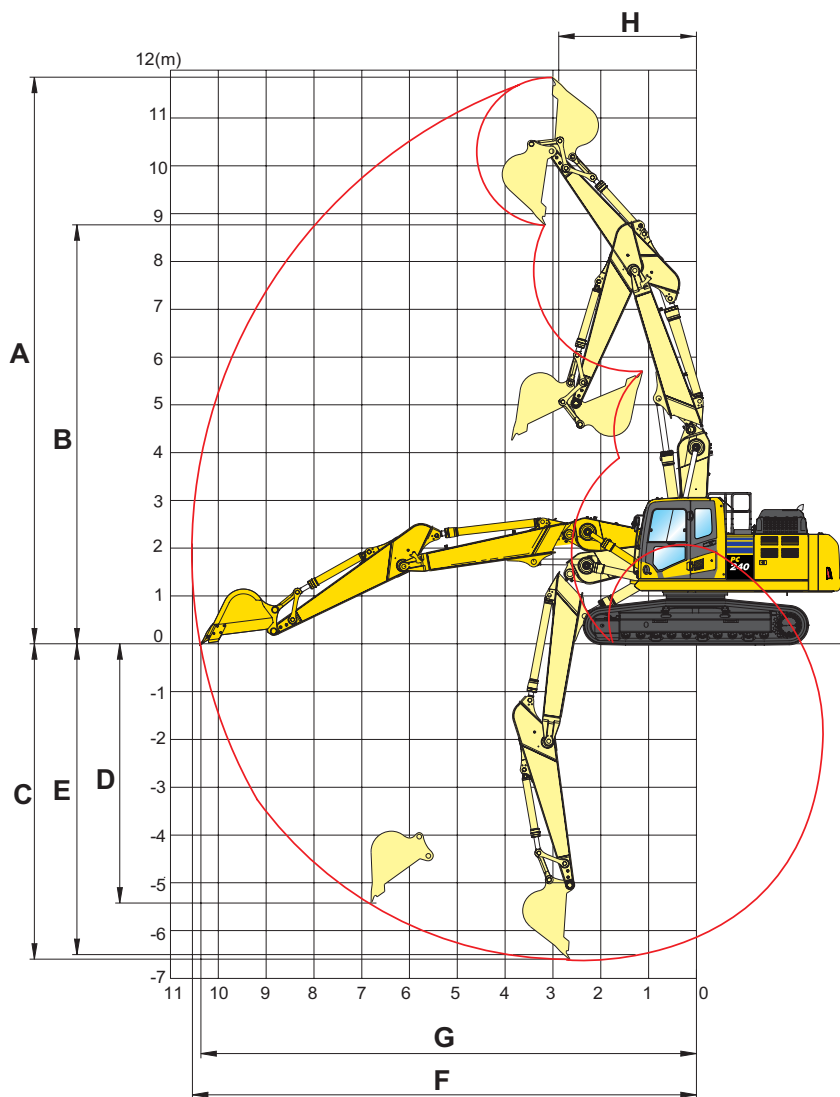

Working range

| Arm length | 2.5 m | 3.0 m | 3.5 m |
|--|----------|----------|----------|
| A Max. digging height | 11360 mm | 11855 mm | 12180 mm |
| B Max. dumping height | 8265 mm | 8745 mm | 9245 mm |
| C Max. digging depth | 6130 mm | 6600 mm | 7035 mm |
| D Max. vertical wall digging depth | 4800 mm | 5430 mm | 5765 mm |
| E Max. digging depth of cut for 2.44 m level | 6030 mm | 6505 mm | 6950 mm |
| F Max. digging reach | 10000 mm | 10550 mm | 10965 mm |
| G Max. digging reach at ground level | 9885 mm | 10380 mm | 10790 mm |
| H Min. swing radius | 2945 mm | 2875 mm | 3005 mm |

Lifting capacity

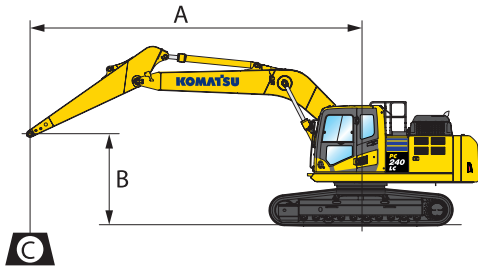

A – Reach from swing center

B – Bucket hook height

C – Lifting capacities

– Rating over front

– Rating over side

– Rating at maximum reach

Weights:

With 2.0 and 2.5 m arm:
bucket linkage and
bucket cylinder: 390 kg
With 3.0 and 3.5 m arm:
bucket linkage and
bucket cylinder: 363 kg

PC240LC-11 Mono boom

With 700 mm shoes

| Arm length | A | | | | 9.0 m | | 7.5 m | | 6.0 m | | 4.5 m | | 3.0 m | | 1.5 m | | |
|------------|--------|----|-------|-------|-------|--|-------|-------|-------|-------|--------|--------|--------|--------|--------|--------|--|
| | B | | | | | | | | | | | | | | | | |
| 3.5 m | 6.0 m | kg | *3870 | *3870 | | | *5520 | 5100 | *5740 | *5740 | | | | | | | |
| | 4.5 m | kg | *3860 | *3860 | | | *6380 | 5000 | *6630 | *6630 | | | | | | | |
| | 3.0 m | kg | *3990 | 3700 | | | *7050 | 4840 | *7950 | 6690 | *9860 | *9860 | *15240 | *15240 | | | |
| | 1.5 m | kg | *4250 | 3580 | | | 6890 | 4660 | *9340 | 6350 | *12530 | 9500 | | | | | |
| | 0.0 m | kg | *4710 | 3630 | | | 6730 | 4510 | 9320 | 6080 | *14310 | 9050 | *8510 | *8510 | | | |
| | -1.5 m | kg | *5490 | 3870 | | | 6640 | 4440 | 9160 | 5940 | 14570 | 8870 | *12140 | *12140 | *7760 | *7760 | |
| | -3.0 m | kg | 6590 | 4410 | | | 6670 | 4460 | 9140 | 5930 | 14590 | 8880 | *17390 | *17390 | *11910 | *11910 | |
| | -4.5 m | kg | 8640 | 5690 | | | | | 9310 | 6070 | | | | | | | |
| 3.0 m | 6.0 m | kg | *4460 | *4460 | | | *4990 | *4990 | *6370 | *6370 | | | | | | | |
| | 4.5 m | kg | *4440 | 4290 | | | *6870 | 4970 | *7240 | 6960 | *8150 | *8150 | | | | | |
| | 3.0 m | kg | *4590 | 3960 | | | 7070 | 4830 | *8520 | 6650 | *10840 | 10080 | | | | | |
| | 1.5 m | kg | *4910 | 3850 | | | 6900 | 4680 | 9600 | 6340 | *13340 | 9440 | | | | | |
| | 0.0 m | kg | *5480 | 3910 | | | 6770 | 4560 | 9360 | 6130 | *14800 | 9100 | *7560 | *7560 | | | |
| | -1.5 m | kg | 6220 | 4210 | | | 6710 | 4510 | 9240 | 6030 | 14700 | 8990 | *12510 | *12510 | *8160 | *8160 | |
| | -3.0 m | kg | 7310 | 4890 | | | | | 9270 | 6050 | *14660 | 9040 | *19180 | 17770 | *13240 | *13240 | |
| | -4.5 m | kg | | | | | | | | | | | | | | | |
| 2.5 m | 6.0 m | kg | *6610 | 5530 | | | | | *7080 | 7050 | | | | | | | |
| | 4.5 m | kg | *6620 | 4710 | | | 7130 | 4890 | *7880 | 6840 | *9180 | *9180 | | | | | |
| | 3.0 m | kg | 6300 | 4310 | | | 7000 | 4770 | *9090 | 6550 | *11850 | 9830 | | | | | |
| | 1.5 m | kg | 6130 | 4180 | | | 6860 | 4640 | 9510 | 6270 | *14080 | 9280 | | | | | |
| | 0.0 m | kg | 6310 | 4270 | | | 6760 | 4550 | 9310 | 6090 | 14750 | 9030 | | | | | |
| | -1.5 m | kg | 6930 | 4660 | | | | | 9250 | 6030 | 14710 | 9000 | *13550 | *13550 | | | |
| | -3.0 m | kg | 8460 | 5600 | | | | | 9340 | 6110 | *14160 | 9120 | *19730 | 17970 | | | |
| | -4.5 m | kg | | | | | | | | | | | | | | | |
| 2.0 m | 6.0 m | kg | *7010 | 6100 | | | | | *7810 | 6980 | *8190 | *8190 | | | | | |
| | 4.5 m | kg | *6960 | 5110 | | | | | *8500 | 6800 | *10170 | *10170 | | | | | |
| | 3.0 m | kg | 6800 | 4650 | | | 7000 | 4780 | *9630 | 6520 | *12840 | 9700 | | | | | |
| | 1.5 m | kg | 6620 | 4510 | | | 6890 | 4680 | 9520 | 6280 | *14770 | 9240 | | | | | |
| | 0.0 m | kg | 6860 | 4640 | | | | | 9370 | 6150 | 14820 | 9100 | | | | | |
| | -1.5 m | kg | 7650 | 5130 | | | | | 9350 | 6130 | 14850 | 9130 | *13800 | *13800 | | | |
| | -3.0 m | kg | | | | | | | | | | | | | | | |
| | -4.5 m | kg | | | | | | | | | | | | | | | |

* Load is limited by hydraulic capacity rather than tipping. Ratings are based on SAE Standard No. J1097.

Rated loads do not exceed 87% of hydraulic lift capacity or 75% of tipping load. Lifting capacity stated is based on lifting with bare arm.

When lifting with additional equipment installed to the arm, please subtract the weight of all additional equipment from the values stated.

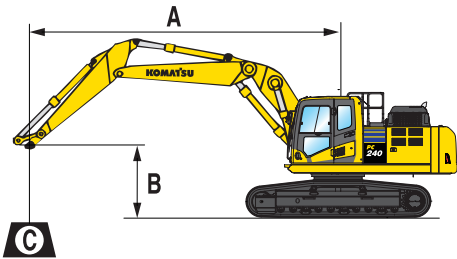

A – Reach from swing center

B – Bucket hook height

C – Lifting capacities

– Rating over front

– Rating over side

– Rating at maximum reach

Weights:

With 2.5 m arm: bucket linkage

and bucket cylinder: 390 kg

With 3.0 and 3.5 m arm: bucket linkage

and bucket cylinder: 363 kg

PC240LC-11 Two-piece boom

With 700 mm shoes

| Arm length | A | | | | 9.0 m | | 7.5 m | | 6.0 m | | 4.5 m | | 3.0 m | | 1.5 m | | |
|------------|--------|----|-------|-------|-------|------|-------|-------|-------|--------|--------|-------|-------|-------|-------|--|--|
| | B | | | | | | | | | | | | | | | | |
| 3.5 m | 7.5 m | kg | *4000 | *4000 | | | *4250 | *4250 | *6450 | *6450 | | | | | | | |
| | 6.0 m | kg | *3750 | *3750 | | | *6300 | 4900 | *6750 | *6750 | *6300 | *6300 | | | | | |
| | 4.5 m | kg | *3700 | 3500 | | | *6950 | 4750 | *7650 | 6750 | *8200 | *8200 | *7950 | *7950 | | | |
| | 3.0 m | kg | *3750 | 3250 | | | 6850 | 4600 | *8750 | 6350 | *11200 | 9700 | | | | | |
| | 1.5 m | kg | *3900 | 3200 | | | 6650 | 4400 | 9300 | 6000 | *13200 | 8950 | | | | | |
| | 0.0 m | kg | *4200 | 3250 | | | 6500 | 4250 | 9000 | 5700 | 14300 | 8500 | | | | | |
| | -1.5 m | kg | *4700 | 3450 | | | 6450 | 3850 | 8850 | 5600 | 14150 | 8400 | *9500 | *9500 | | | |
| -3.0 m | kg | | | | | 6500 | 3900 | 8900 | 5650 | *13700 | 8450 | | | | | | |
| 3.0 m | 7.5 m | kg | *4650 | *4650 | | | | | *7200 | 7000 | *7350 | *7350 | | | | | |
| | 6.0 m | kg | *4350 | 4300 | | | 6600 | 4800 | *7400 | 6900 | *7550 | *7550 | | | | | |
| | 4.5 m | kg | *4250 | 3750 | | | 7000 | 4750 | *8150 | 6650 | *9750 | *9750 | | | | | |
| | 3.0 m | kg | *4300 | 3500 | | | 6850 | 4550 | *9250 | 6300 | *12050 | 9550 | | | | | |
| | 1.5 m | kg | *4500 | 3450 | | | 6650 | 4400 | 9300 | 6000 | *13800 | 8900 | | | | | |
| | 0.0 m | kg | *4850 | 3500 | | | 6550 | 4300 | 9050 | 5750 | 14350 | 8600 | | | | | |
| | -1.5 m | kg | *5450 | 3750 | | | 6500 | 3900 | 8950 | 5700 | 14300 | 8550 | *9650 | *9650 | | | |
| -3.0 m | kg | | | | | | | 9050 | 5750 | *13300 | 8650 | | | | | | |
| 2.5 m | 7.5 m | kg | *7050 | 6250 | | | | | *7950 | 6800 | *8200 | *8200 | | | | | |
| | 6.0 m | kg | *6550 | 4800 | | | | | *7950 | 6750 | *8900 | *8900 | | | | | |
| | 4.5 m | kg | 6200 | 4150 | | | 6950 | 4650 | *8700 | 6500 | *10650 | 10100 | | | | | |
| | 3.0 m | kg | 5750 | 3850 | | | 6800 | 4500 | 9500 | 6200 | *12850 | 9300 | | | | | |
| | 1.5 m | kg | 5600 | 3750 | | | 6650 | 4400 | 9200 | 5900 | | | | | | | |
| | 0.0 m | kg | 5750 | 3850 | | | 6550 | 4300 | 9000 | 5750 | 14300 | 8550 | | | | | |
| | -1.5 m | kg | 6350 | 4200 | | | 6550 | 3900 | 9000 | 5700 | *14150 | 8600 | | | | | |
| -3.0 m | kg | | | | | | | | | | | | | | | | |

* Load is limited by hydraulic capacity rather than tipping. Ratings are based on SAE Standard No. J1097.

Rated loads do not exceed 87% of hydraulic lift capacity or 75% of tipping load. Lifting capacity stated is based on lifting with bare arm.

When lifting with additional equipment installed to the arm, please subtract the weight of all additional equipment from the values stated.

Lifting capacity

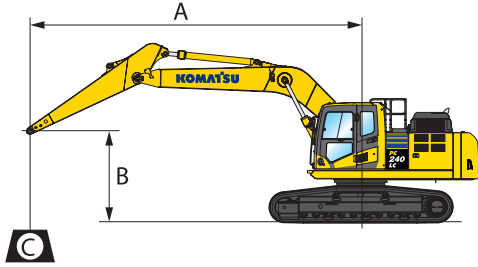

A – Reach from swing center

B – Bucket hook height

C – Lifting capacities

– Rating over front

– Rating over side

– Rating at maximum reach

Weights:

With 2.0 and 2.5 m arm:

bucket linkage and

bucket cylinder: 390 kg

With 3.0 and 3.5 m arm:

bucket linkage and

bucket cylinder: 363 kg

PC240NLC-11 Mono boom

With 600 mm shoes

| Arm length | A | | | | 9.0 m | | 7.5 m | | 6.0 m | | 4.5 m | | 3.0 m | | 1.5 m | |
|------------|--------|----|-------|-------|-------|--|-------|------|-------|-------|--------|-------|--------|--------|--------|--------|
| | B | | | | | | | | | | | | | | | |
| 3.5 m | 6.0 m | kg | *3870 | *3870 | | | *5520 | 4580 | *5740 | *5740 | | | | | | |
| | 4.5 m | kg | *3860 | 3560 | | | *6380 | 4480 | *6630 | 6300 | | | | | | |
| | 3.0 m | kg | *3990 | 3290 | | | 6420 | 4320 | *7950 | 5970 | *9860 | 9050 | *15240 | *15240 | | |
| | 1.5 m | kg | *4250 | 3180 | | | 6230 | 4140 | 8660 | 5630 | *12530 | 8350 | | | | |
| | 0.0 m | kg | *4710 | 3220 | | | 6070 | 4000 | 8370 | 5370 | 13120 | 7910 | *8510 | *8510 | | |
| | -1.5 m | kg | 5180 | 3430 | | | 5990 | 3920 | 8220 | 5240 | 12910 | 7740 | *12140 | *12140 | *7760 | *7760 |
| | -3.0 m | kg | 5950 | 3910 | | | 6010 | 3950 | 8200 | 5220 | 12920 | 7750 | *17390 | 14820 | *11910 | *11910 |
| | -4.5 m | kg | 7770 | 5030 | | | | | 8360 | 5360 | | | | | | |
| 3.0 m | 6.0 m | kg | *4460 | 4420 | | | *4990 | 4520 | *6370 | *6370 | | | | | | |
| | 4.5 m | kg | *4440 | 3830 | | | 6560 | 4450 | *7240 | 6240 | *8150 | *8150 | | | | |
| | 3.0 m | kg | *4590 | 3530 | | | 6410 | 4320 | *8520 | 5930 | *10840 | 8920 | | | | |
| | 1.5 m | kg | *4910 | 3420 | | | 6240 | 4160 | 8650 | 5630 | *13340 | 8300 | | | | |
| | 0.0 m | kg | 5210 | 3480 | | | 6120 | 4050 | 8410 | 5420 | 13160 | 7960 | *7560 | *7560 | | |
| | -1.5 m | kg | 5630 | 3730 | | | 6060 | 4000 | 8300 | 5320 | 13030 | 7860 | *12510 | *12510 | *8160 | *8160 |
| | -3.0 m | kg | 6600 | 4340 | | | | | 8320 | 5340 | 13100 | 7910 | *19180 | 15150 | *13240 | *13240 |
| | -4.5 m | kg | | | | | | | | | | | | | | |
| 2.5 m | 6.0 m | kg | *6610 | 4950 | | | | | *7080 | 6320 | | | | | | |
| | 4.5 m | kg | 6220 | 4210 | | | 6470 | 4370 | *7880 | 6120 | *9180 | *9180 | | | | |
| | 3.0 m | kg | 5710 | 3840 | | | 6340 | 4260 | 8870 | 5830 | *11850 | 8680 | | | | |
| | 1.5 m | kg | 5550 | 3710 | | | 6200 | 4130 | 8570 | 5560 | 13370 | 8140 | | | | |
| | 0.0 m | kg | 5710 | 3790 | | | 6110 | 4040 | 8370 | 5380 | 13090 | 7900 | | | | |
| | -1.5 m | kg | 6260 | 4130 | | | | | 8310 | 5330 | 13050 | 7870 | *13550 | *13550 | | |
| | -3.0 m | kg | 7620 | 4960 | | | | | 8390 | 5400 | 13180 | 7980 | *19730 | 15330 | | |
| | -4.5 m | kg | | | | | | | | | | | | | | |
| 2.0 m | 6.0 m | kg | *7010 | 5460 | | | | | *7810 | 6250 | *8190 | *8190 | | | | |
| | 4.5 m | kg | 6770 | 4570 | | | | | *8500 | 6080 | *10170 | 9230 | | | | |
| | 3.0 m | kg | 6170 | 4150 | | | 6340 | 4260 | 8840 | 5810 | *12840 | 8560 | | | | |
| | 1.5 m | kg | 6000 | 4010 | | | 6230 | 4160 | 8570 | 5570 | 13320 | 8110 | | | | |
| | 0.0 m | kg | 6200 | 4120 | | | | | 8420 | 5440 | 13150 | 7970 | | | | |
| | -1.5 m | kg | 6910 | 4560 | | | | | 8400 | 5420 | 13180 | 8000 | *13800 | *13800 | | |
| | -3.0 m | kg | | | | | | | | | | | | | | |
| | -4.5 m | kg | | | | | | | | | | | | | | |

* Load is limited by hydraulic capacity rather than tipping. Ratings are based on SAE Standard No. J1097.

Rated loads do not exceed 87% of hydraulic lift capacity or 75% of tipping load. Lifting capacity stated is based on lifting with bare arm.

When lifting with additional equipment installed to the arm, please subtract the weight of all additional equipment from the values stated.

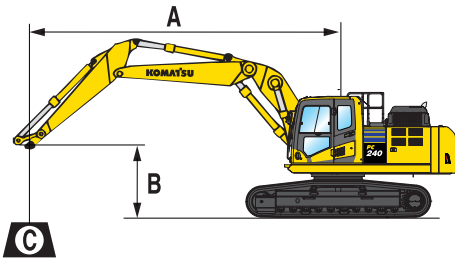

A – Reach from swing center

B – Bucket hook height

C – Lifting capacities

– Rating over front

– Rating over side

– Rating at maximum reach

Weights:

With 2.5 m arm: bucket linkage

and bucket cylinder: 390 kg

With 3.0 and 3.5 m arm: bucket linkage

and bucket cylinder: 363 kg

PC240NLC-11 Two-piece boom

With 700 mm shoes

| Arm length | A | | | | 9.0 m | | 7.5 m | | 6.0 m | | 4.5 m | | 3.0 m | | 1.5 m | | |
|--------------|--------|----|-------|-------|-------|------|-------|-------|-------|-------|--------|-------|-------|-------|-------|--|--|
| | B | | | | | | | | | | | | | | | | |
| <p>3.5 m</p> | 7.5 m | kg | *4000 | *4000 | | | *4250 | *4250 | *6450 | 6400 | | | | | | | |
| | 6.0 m | kg | *3750 | 3500 | | | *6300 | 4350 | *6750 | 6250 | *6300 | *6300 | | | | | |
| | 4.5 m | kg | *3700 | 3100 | | | 6400 | 4250 | *7650 | 6000 | *8200 | *8200 | *7950 | *7950 | | | |
| | 3.0 m | kg | *3750 | 2850 | | | 6200 | 4050 | 8750 | 5600 | *11200 | 8550 | | | | | |
| | 1.5 m | kg | *3900 | 2800 | | | 6000 | 3850 | 8350 | 5250 | 12950 | 7800 | | | | | |
| | 0.0 m | kg | *4200 | 2850 | | | 5850 | 3700 | 8050 | 5000 | 12600 | 7400 | | | | | |
| | -1.5 m | kg | *4700 | 3050 | | | 5750 | 3300 | 7900 | 4900 | 12450 | 7250 | *9500 | *9500 | | | |
| -3.0 m | kg | | | | | 5800 | 3350 | 7950 | 4900 | 12550 | 7350 | | | | | | |
| <p>3.0 m</p> | 7.5 m | kg | *4650 | *4650 | | | | | *7200 | 6250 | *7350 | *7350 | | | | | |
| | 6.0 m | kg | *4350 | 3800 | | | 6450 | 4300 | *7400 | 6200 | *7550 | *7550 | | | | | |
| | 4.5 m | kg | *4250 | 3350 | | | 6350 | 4200 | *8150 | 5900 | *9750 | 9200 | | | | | |
| | 3.0 m | kg | *4300 | 3100 | | | 6200 | 4050 | 8700 | 5600 | *12050 | 8400 | | | | | |
| | 1.5 m | kg | *4500 | 3000 | | | 6000 | 3900 | 8350 | 5250 | 12900 | 7750 | | | | | |
| | 0.0 m | kg | 4750 | 3100 | | | 5900 | 3800 | 8100 | 5050 | 12700 | 7450 | | | | | |
| | -1.5 m | kg | 5150 | 3300 | | | 5850 | 3750 | 8000 | 5000 | 12650 | 7400 | *9650 | *9650 | | | |
| -3.0 m | kg | | | | | | | 8100 | 5050 | 12800 | 7500 | | | | | | |
| <p>2.5 m</p> | 7.5 m | kg | *7050 | 5550 | | | | | *7950 | 6050 | *8200 | *8200 | | | | | |
| | 6.0 m | kg | 6500 | 4250 | | | | | *7950 | 6050 | *8900 | *8900 | | | | | |
| | 4.5 m | kg | 5600 | 3650 | | | 6250 | 4100 | *8700 | 5800 | *10650 | 8900 | | | | | |
| | 3.0 m | kg | 5150 | 3400 | | | 6100 | 4000 | 8550 | 5450 | *12850 | 8150 | | | | | |
| | 1.5 m | kg | 5050 | 3300 | | | 5950 | 3850 | 8250 | 5200 | | | | | | | |
| | 0.0 m | kg | 5200 | 3350 | | | 5900 | 3800 | 8050 | 5050 | 12650 | 7400 | | | | | |
| | -1.5 m | kg | 5700 | 3700 | | | 5900 | 3470 | 8050 | 5000 | 12650 | 7450 | | | | | |
| -3.0 m | kg | | | | | | | | | | | | | | | | |

* Load is limited by hydraulic capacity rather than tipping. Ratings are based on SAE Standard No. J1097.

Rated loads do not exceed 87% of hydraulic lift capacity or 75% of tipping load. Lifting capacity stated is based on lifting with bare arm.

When lifting with additional equipment installed to the arm, please subtract the weight of all additional equipment from the values stated.

Standard and optional equipment

Engine

| | |
|---|---|
| Komatsu SAA6D107E-3 turbocharged common rail direct injection diesel engine | ● |
| EU Stage V compliant | ● |
| Suction type cooling fan with radiator fly screen | ● |
| Automatic engine warm-up system | ● |
| Engine overheat prevention system | ● |
| Fuel control dial | ● |
| Auto-deceleration function | ● |
| Adjustable idle shutdown | ● |
| Engine key stop | ● |
| Engine ignition can be password secured on request | ● |
| Alternator 24 V / 90 A | ● |
| Starter motor 24 V / 5.5 kW | ● |
| Batteries 2 × 12 V / 180 Ah | ● |

Hydraulic system

| | |
|---|---|
| Electronic closed-centre load sensing (E-CLSS) hydraulic system (HydraMind) | ● |
| Pump and engine mutual control (PEMC) system | ● |
| 6-working mode selection system; Power mode, Economy mode, Breaker mode, Attachment Power and Attachment Economy mode, and Lifting mode | ● |
| PowerMax function | ● |
| PPC wrist control levers for arm, boom, bucket and swing, with sliding proportional control for attachments and 3 auxiliary buttons | ● |
| Prepared for hydraulic quick-coupler | ● |
| Additional hydraulic functions | ○ |
| Komatsu Integrated Attachment Control (KIAC) | ○ |

Undercarriage

| | |
|--|---|
| Track roller guards | ● |
| Track frame under-guards | ● |
| 600, 700, 800, 900 mm triple grouser shoes | ○ |
| Full length track roller guards | ○ |

Drives and brakes

| | |
|---|---|
| Hydrostatic, 3-speed travel system with automatic shift and planetary gear type final drives, and hydraulic travel and parking brakes | ● |
| PPC control levers and pedals for steering and travel | ● |

Cabin

| | |
|--|---|
| Reinforced safety SpaceCab™; highly pressurised and tightly sealed hyper viscous mounted cab with tinted safety glass windows, large roof window with sun shade, pull-up type front window with locking device, removable lower window, front window wiper with intermittent feature, sun roller blind, cigarette lighter, ashtray, luggage shelf, floor mat | ● |
| Heated, high-back air-suspended seat with lumbar support, console mounted height adjustable arm rests, and retractable seat belt | ● |
| Automatic climate control system | ● |
| 12 / 24 Volt power supplies | ● |
| Beverage holder and magazine rack | ● |
| Hot and cool box | ● |
| Radio (AM/FM) | ● |
| Auxiliary input (MP3 jack) | ● |
| Lower wiper | ○ |
| Rain visor (not with OPG) | ○ |
| DAB+ digital radio w. auxiliary input (MP3 jack) | ○ |

Service and maintenance

| | |
|--|---|
| Automatic fuel line de-aeration | ● |
| Double element type air cleaner with dust indicator and auto dust evacuator | ● |
| Komtrax – Komatsu wireless monitoring system (4G) | ● |
| Komatsu Care – a maintenance program for Komatsu customers | ● |
| Multifunction video compatible colour monitor with Equipment Management and Monitoring System (EMMS) and efficiency guidance | ● |
| Toolkit | ● |
| Service points | ○ |
| Automatic greasing system | ○ |

LED lighting system

| | |
|--|---|
| Working lights: 2 revolving frame, 1 boom (l.h.) | ● |
| Additional working lights (#1): 2 cab roof (front), 1 cab roof (rear), 1 boom (r.h.), 1 counterweight, beacon | ○ |
| Additional working lights (#2): 4 cab roof (front), 1 cab roof (rear), 1 boom (r.h.), 1 counterweight, 2 boom cylinders, 2 revolving frame (l.h. + r.h.), beacon | ○ |

Safety equipment

| | |
|--|---|
| KomVision surround view system | ● |
| Electric horn | ● |
| Overload warning device | ● |
| Audible travel alarm | ● |
| Boom safety valves | ● |
| Large handrails, rear-view mirrors | ● |
| Battery main switch | ● |
| ROPS compliant to ISO 12117-2:2008 | ● |
| Emergency engine stop switch | ● |
| Seat belt caution indicator | ● |
| Neutral position detection system | ● |
| Arm safety valve | ● |
| OPG Level II front guard (FOPS), hinged type | ○ |
| OPG Level II top guard (FOPS) | ○ |

Work equipment

| | |
|---------------------------------|---|
| Mono boom | ○ |
| Two-piece boom | ○ |
| Bucket linkage with lifting eye | ○ |
| 2.0 m; 2.5 m; 3.0 m; 3.5 m arms | ○ |
| Komatsu buckets | ○ |
| Komatsu breakers | ○ |

Other equipment

| | |
|---|---|
| Standard counterweight | ● |
| Remote greasing for swing circle and pins | ● |
| Electric refuelling pump with automatic shut-off function | ● |
| Biodegradable oil for hydraulic system | ○ |
| Customised paint | ○ |

Further equipment on request

- standard equipment
- optional equipment



A wide range of buckets and attachments is available. Your Komatsu distributor is ready to assist you with the selection of suitable options.

This specification sheet may contain attachments and optional equipment that are not available in your area. Please consult your local Komatsu distributor for those items you may require. Materials and specifications are subject to change without notice.

Your Komatsu partner:

KOMATSU

[komatsu.eu](https://www.komatsu.eu)

